

DNP Master Serial Driver Help

© 2010 Kepware Technologies

Table of Contents

1	Getting Started	4
	Help Contents	4
	Overview	4
2	Channel Setup	4
	Channel Setup	4
3	Device Setup	5
	Device Setup	5
	Communications	6
	Polling	7
	Unsolicited Messaging	9
	Event Playback	9
	Advanced	10
	Timing and Other Considerations	11
	Modem Setup	12
4	Data Types Description	12
	Data Types Description	12
5	Address Descriptions	13
	Address Descriptions	13
	DNP Addressing	16
	Object Definitions	20
	DNP Advanced Operations	22
6	Error Descriptions	23
	Error Descriptions	23
	Address Validation	24
	Address Validation	24
	Address '<address>' is not valid on device '<channel>' '<device>'	24
	Address '<address>' is out of range for the specified device or register	25
	Data type '<type>' is not valid for device address '<address>'	25
	Device address '<address>' contains a syntax error	25
	Device address '<address>' is read only	25
	Device Status Messages	25
	Device Status Messages	25
	Device '<device>' does not support the LAN Time Sync Style Record Current Time Function Code 24	26
	Device '<device>' indicated an event buffer overflow (IIN 2.3)	26
	Device '<device>' Restarting	26
	Device '<device name>' is not responding	26
	Reached Max Events Per Point for Object Group '<object group>' Point '<data index>' on Device '<device>'	27
	Unable to read point(s) '<OBJ.VAR.IDX>' on device '<device>'. Failed to initialize communication stack	27
	Unable to read point(s) '<OBJ.VAR.IDX>' on device '<device>'. Internal Error occurred	27
	Unable to read point(s) '<OBJ.VAR.IDX – OBJ.VAR.IDX>' on device '<device>'. Failed to initialize communication stack	28
	Unable to read point(s) '<OBJ.VAR.IDX – OBJ.VAR.IDX>' on device '<device>'. Internal Error occurred	28
	Unable to receive entire poll response from device '<device>' within Response Timeout. Increase Response Timeout to resolve	28
	Unable to write to '<address>' on device '<device>'. Failed to initialize communication stack	28
	Unable to write to '<address>' on device '<device>'. Internal Error occurred	29

DNP Specific Error Messages.....	29
DNP Specific Error Messages.....	29
Read Errors.....	29
Read Errors	29
Unable to read point(s) '<OBJ.VAR.IDX>' on device '<device>'. An abnormal condition exists in the device (IIN1.6)	30
Unable to read point(s) '<OBJ.VAR.IDX>' on device '<device>'. Device detected corrupt configuration (IIN2.5)	30
Unable to read point(s) '<OBJ.VAR.IDX>' on device '<device>'. Device does not support a point in the range or other parameter error (IIN2.2).....	30
Unable to read point(s) '<OBJ.VAR.IDX>' on device '<device>'. Device does not support requested operation for objects in the request (IIN2.1).....	30
Unable to read point(s) '<OBJ.VAR.IDX>' on device '<device>'. Device does not support the function code (IIN2.0)	31
Unable to read point(s) '<OBJ.VAR.IDX>' on device '<device>'. Device reports that some output points are in local mode (IIN1.5).....	31
Unable to read point(s) '<OBJ.VAR.IDX>' on device '<device>'. Device reports that the operation is already executing (IIN2.4).....	31
Unable to read point(s) '<OBJ.VAR.IDX>' on device '<device>'. Response missing data.....	31
Unable to read point(s) '<OBJ.VAR.IDX>' on device '<device>'. Session shutting down or duplicate request	32
Unable to read point(s) '<OBJ.VAR.IDX>' on device '<device>'. Unrecognized Object returned in Response	32
Unable to read point(s) '<OBJ.VAR.IDX – OBJ.VAR.IDX>' on device '<device>'. An abnormal condition exists in the device (IIN1.6).....	32
Unable to read point(s) '<OBJ.VAR.IDX – OBJ.VAR.IDX>' on device '<device>'. Device detected corrupt configuration (IIN2.5).....	32
Unable to read point(s) '<OBJ.VAR.IDX – OBJ.VAR.IDX>' on device '<device>'. Device does not support a point in the range or other parameter error (IIN2.2).....	32
Unable to read point(s) '<OBJ.VAR.IDX – OBJ.VAR.IDX>' on device '<device>'. Device does not support requested operation for objects in the request (IIN2.1).....	33
Unable to read point(s) '<OBJ.VAR.IDX – OBJ.VAR.IDX>' on device '<device>'. Device does not support the function code (IIN2.0).....	33
Unable to read point(s) '<OBJ.VAR.IDX – OBJ.VAR.IDX>' on device '<device>'. Device reports that some output points are in local mode (IIN1.5).....	33
Unable to read point(s) '<OBJ.VAR.IDX – OBJ.VAR.IDX>' on device '<device>'. Device reports that the operation is already executing (IIN2.4).....	33
Unable to read point(s) '<OBJ.VAR.IDX – OBJ.VAR.IDX>' on device '<device>'. Response missing data	34
Unable to read point(s) '<OBJ.VAR.IDX – OBJ.VAR.IDX>' on device '<device>'. Session shutting down or duplicate request.....	34
Unable to read point(s) '<OBJ.VAR.IDX – OBJ.VAR.IDX>' on device '<device>'. Unrecognized Object returned in Response.....	34
Write Errors.....	34
Write Errors	34
Unable to write to '<address>' on device '<device>'. An abnormal condition exists in the device (IIN1.6)	35
Unable to write to '<address>' on device '<device>'. Control-Related Status Code '<status code>'.....	35
Unable to write to '<address>' on device '<device>'. Device detected corrupt configuration (IIN2.5).....	36
Unable to write to '<address>' on device '<device>'. Device does not support a point in the range or other parameter error (IIN2.2).....	36
Unable to write to '<address>' on device '<device>'. Device does not support requested operation for objects in the request (IIN2.1).....	36
Unable to write to '<address>' on device '<device>'. Device does not support the function code (IIN2.0)	36
Unable to write to '<address>' on device '<device>'. Device reports that some output points are in local mode (IIN1.5).....	37
Unable to write to '<address>' on device '<device>'. Device reports that the operation is already executing (IIN2.4).....	37
Unable to write to '<address>' on device '<device>'. Select Operate response invalid.....	37

Unable to write to '<address>' on device '<device>'. Session shutting down or duplicate request.....	37
Unable to write to '<address>' on device '<device>'. Unrecognized Object returned in Response.....	38
Unable to write to '<address>' on device '<device>'. Unsupported Operation Type.....	38
Unable to write to '<address>' on device '<device>'. Unsupported Trip-Close Code.....	38
Unable to write to '<address>' on device '<device>'. Write value specified is invalid.....	38
Unable to write to address '<master address>' on device '<device>'. Master Address must be between '<min master address>' and '<max master address>'.....	38
Unable to write to address '<slave address>' on device '<device>'. Slave Address must be between '<min slave address>' and '<max slave address>'.....	39
7 Device Profile.....	39
Device Profile.....	39
Device Identification.....	39
Application Layer.....	41
Link Layer	41
Masters Only.....	42
 Index	 43

DNP Master Serial Driver Help

Help version 1.079

CONTENTS

[Overview](#)

What is the DNP Master Serial Driver?

[Channel Setup](#)

How do I configure a channel for use with this driver?

[Device Setup](#)

How do I configure a device for use with this driver?

[Data Types Description](#)

What data types does this driver support?

[Address Descriptions](#)

How do I address a data location?

[Error Descriptions](#)

What error messages are produced by this driver?

[Device Profile](#)

Where can I find information on the Device Profile?

Overview

The DNP Master Serial Driver provides an easy and reliable way to connect DNP Master Serial devices to OPC Client applications, including HMI, SCADA, Historian, MES, ERP and countless custom applications.

Channel Setup

In the DNP3 protocol, a channel describes a communications path between two endpoints. DNP3 sessions describe specific communications between a DNP master node (server channel) and a DNP slave node (server device). For each channel (master node), DNP sessions are represented as server devices (slave nodes). Thus, the server channel describes the communications conduit over which the sessions will communicate. The other endpoint of the DNP channel may have one or more slave nodes. To access these settings after the channel has been added, right-click on the channel and then select **Properties | Timing**.

Timing

The Response Timeout specifies how long the device will wait for a response to a request before timing out. The valid range is 100 to 3600000 milliseconds. The default setting is 10000 milliseconds.

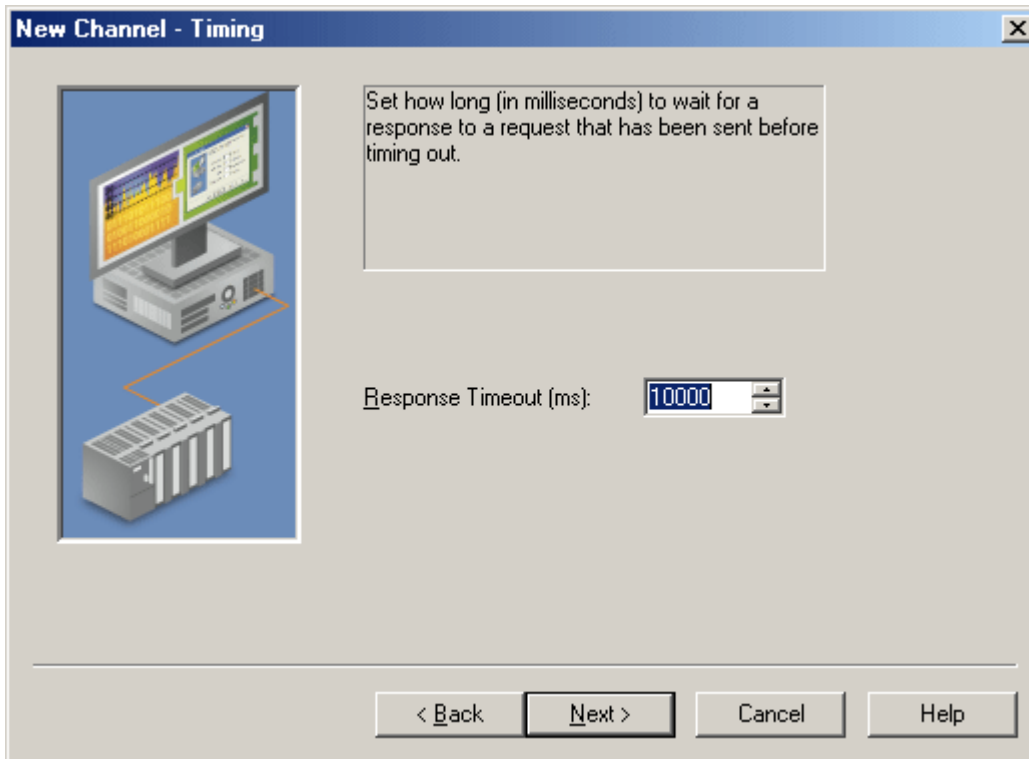

Device Setup

Supported Devices

Any DNP3 slave device.

Communication Protocol

Distributed Network Protocol 3.0 (DNP3).

Maximum Channels and Devices

The maximum number of channels supported by this driver is 1024. The maximum number of devices supported per channel is 1024.

Note: When using Ethernet Encapsulation, this driver uses one socket per channel.

Flow Control and RS232/485 Converters

When using an RS232/RS485 converter, the type of flow control that is required depends on the needs of the converter. Some converters do not require any flow control whereas others require RTS flow. Consult the converter's documentation in order to determine its flow requirements. An RS485 converter that provides automatic flow control is recommended.

Note: When using the manufacturer's supplied communications cable, it is sometimes necessary to choose a flow control setting of **RTS** or **RTS Always** in the Communications tab in Channel Properties.

Device ID

The Device ID property is not available to this driver.

Cable Diagram

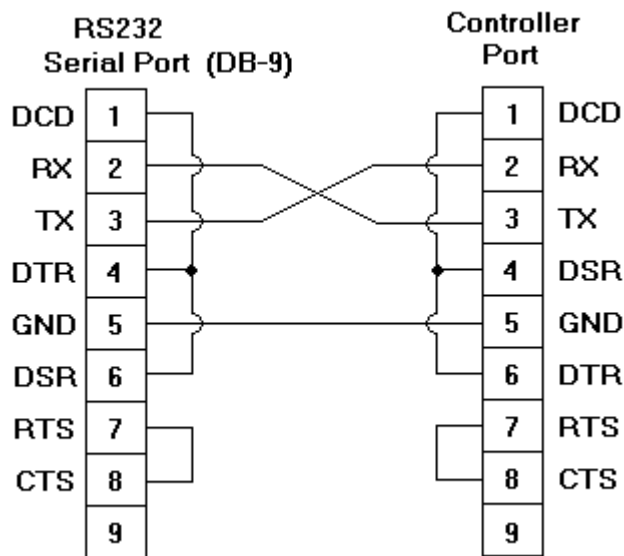

Communications

The Communications dialog is used to specify the DNP Master and Slave's 16 bit addresses.

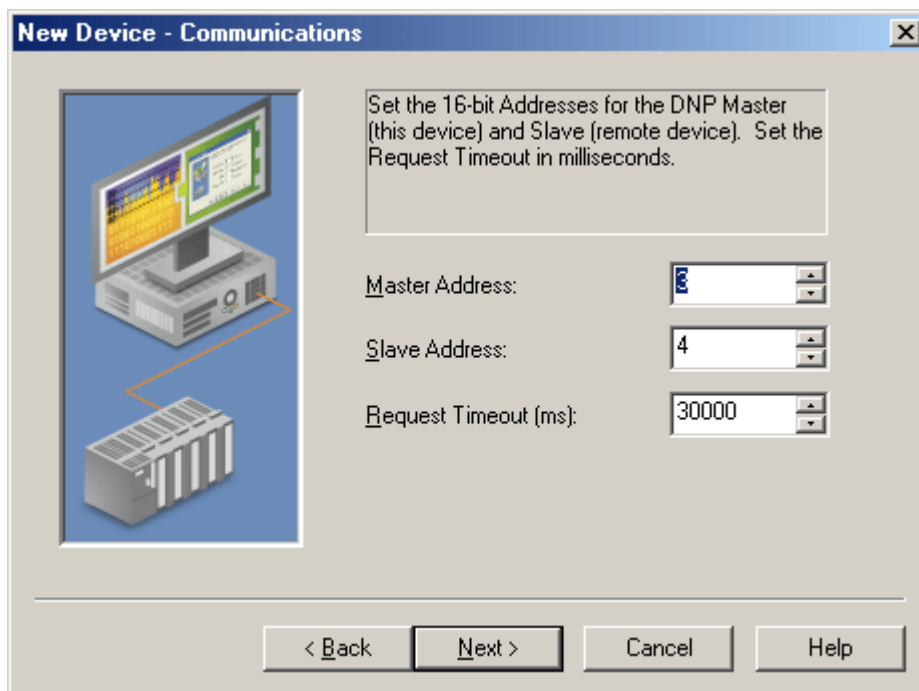

Descriptions of the parameters are as follows:

- **Master Address:** This parameter specifies the address to which the DNP slave devices will talk. The address must be unique and can range from 0 to 65519. Some addresses are reserved. The default setting is 3.
- **Slave Address:** This parameter specifies the slave address. The valid range is 0 to 65519. The default setting is 4.
- **Request Timeout (ms):** This parameter specifies the amount of time in which a command must be completed once it is transmitted. The valid range is 0 to 3600000. The default setting is 30000.

Note: For more information on performance, refer to [Timing and Other Considerations](#).

Time Sync Style

The Communications dialog is also used to specify the device's time synchronization style.

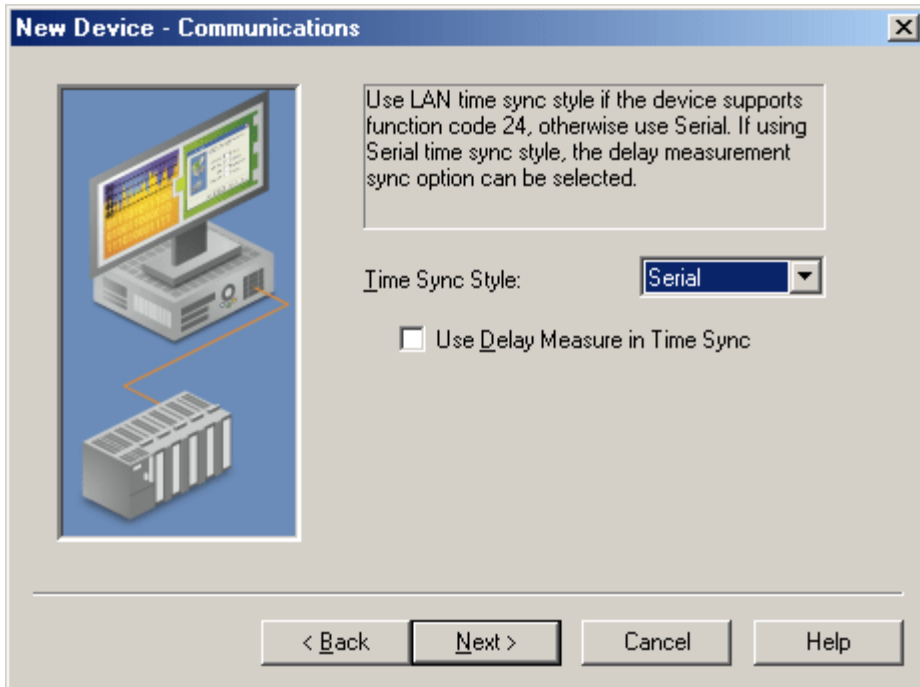

Descriptions of the parameters are as follows:

- **Time Sync Style:** This parameter specifies the DNP master's style of time synchronization, which will be used when a synchronization request is received from the slave. Options include Serial and LAN. In Serial, the DNP master makes a delay measurement using function code 23 over the link and then writes a lag-corrected value using Object 50 - Variation 1. In LAN, the DNP master first sends a request with function code 24 to tell the slave to record the current time. Then, the master writes the current time using Object 50 - Variation 3. The default setting is Serial.
- **Use Delay Measure in Time Sync:** When checked, this parameter specifies that the delay measure function code 23 will be used in time synchronization. This option is only available when the Serial Time Sync Style is selected. The default setting is unchecked.

Polling

Event Class Polling

The Event Class Polling dialog is used to specify the frequency with which each event class will be polled for data changes. The valid range is 0 to 86400 seconds (24 hours). To turn off the event poll for a given class, enter zero (0). The default setting is 5 seconds.

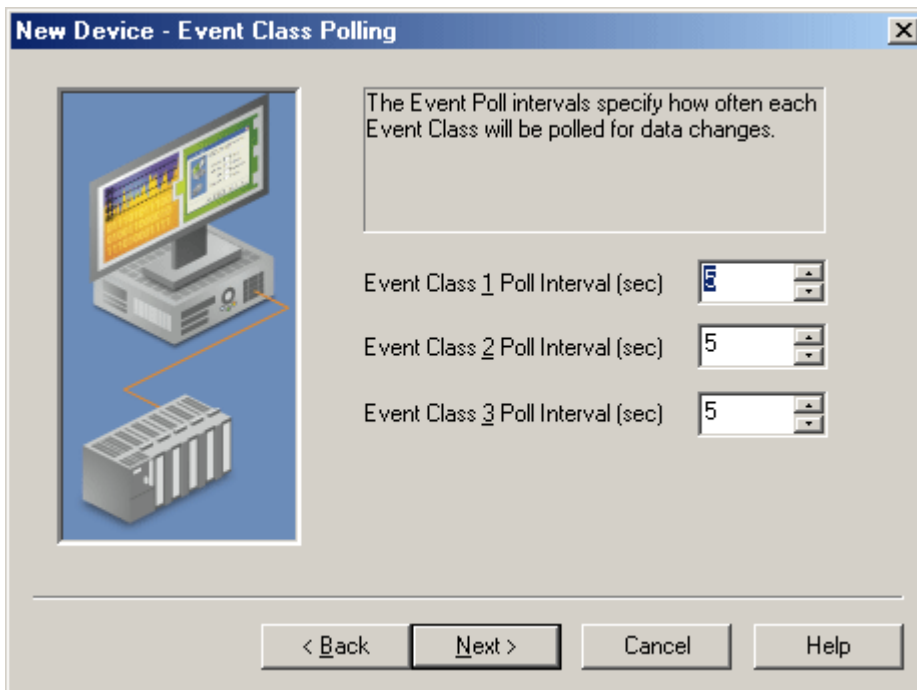

Integrity Polling

The Integrity Polling dialog is used to specify the frequency with which classes 0, 1, 2, and 3 will request data.

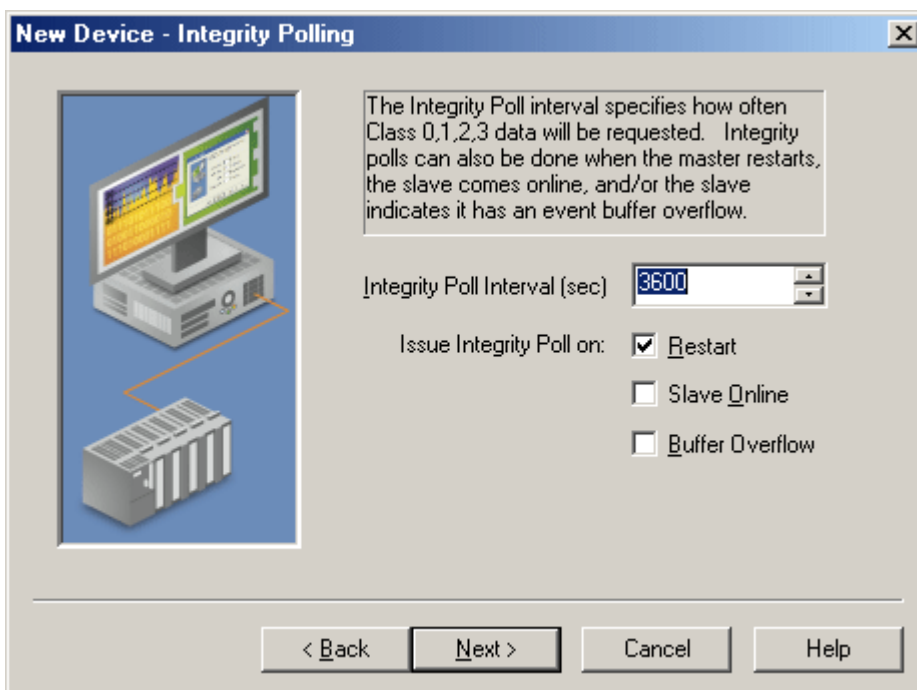

Descriptions of the parameters are as follows:

- **Integrity Poll Interval (sec):** This parameter specifies the frequency with which a complete data retrieval will be requested from the DNP slave device. To turn off integrity polling, enter zero (0). The valid range is 0 to 2,592,000 seconds (30 days). The default setting is 3600 seconds.
- **Issue Integrity Poll on:** This parameter specifies when integrity polls will occur. Options include **Restart**, **Slave Online** and **Buffer Overflow**. The default setting is Restart.

Unsolicited Messaging

The Unsolicited Messaging dialog is used to specify whether the DNP slave will send class 1, 2, and 3 unsolicited data updates.

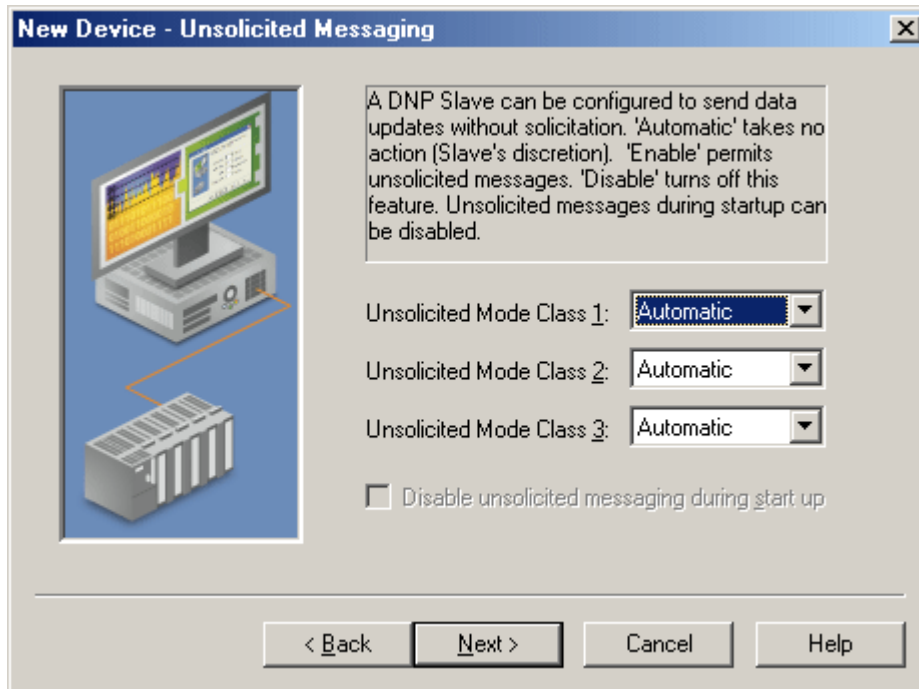

Descriptions of the parameters are as follows:

- **Unsolicited Mode Class 1, 2, and 3:** These parameters specify whether unsolicited messaging will be allowed. Options include **Automatic**, **Enable**, and **Disable**. Automatic takes no action and is at the slave's discretion. Enable permits the reporting of data updates for the selected classes. Disable turns off unsolicited messaging. The default setting is Automatic.
- **Disable unsolicited messaging during start up:** When checked, this option will disable unsolicited messaging during start up. This option is only available when one or more classes have Enable selected and no class has been set to Automatic. This setting applies to all Event classes. The default setting is unchecked.

Event Playback

The Event Playback dialog is used to specify when to retain a set number of updates and then deliver them to clients. DNP slave devices may be configured to retain event reports until contacted by a DNP master. The slave will typically deliver these event reports in bulk when responding to an integrity poll, event poll, or via unsolicited messages. The DNP Driver retains only the most recent update for a given I/O point and discards most or all of the historical stream by default.

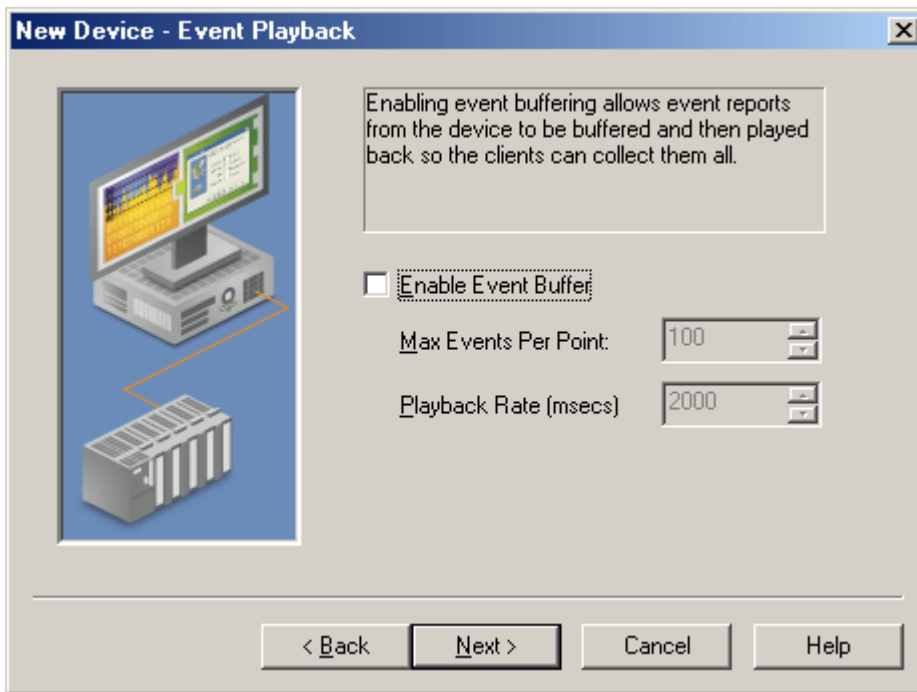

Descriptions of the parameters are as follows:

- **Enable Event Buffer:** When checked, this option allows event reports from the remote DNP device to be buffered and played back for OPC client collection. The default setting is checked.
- **Max Events Per Point:** This parameter specifies the maximum events to be collected per point. The valid range is 1 to 10000. The default setting is 100.
- **Playback Rate (msecs):** This parameter specifies the rate at which event reports will be played back. The valid range is 50 to 10000. The default setting is 2000 milliseconds.

Note: The client's update rate should be at least twice as fast as the Event Playback Rate, so that a client will not miss a buffered event as it is played back.

Note 1: Event Playback introduces latency into the tags for those affected objects. Even after the initial burst of events is played out of the buffer, newly incoming updates will only be reported at the Playback Rate. In the image above, new updates may take up to 2000 milliseconds from the time of arrival to be reported to clients. Buffering should only be used when preservation of the event stream is more important than timely delivery of point updates. If a tag's event buffer fills up, new reports will displace the oldest reports in the queue.

Note 2: To assure retrieval of all the buffered events, the client must have an update rate at least twice as fast as the Playback Rate. Event buffering applies to DNP objects 1, 3, 10, 20, 21 and 30.

Advanced

The Advanced dialog is used to specify the operate mode, whether to perform a feedback poll after a write, and how to display the DNP .Timestamp.

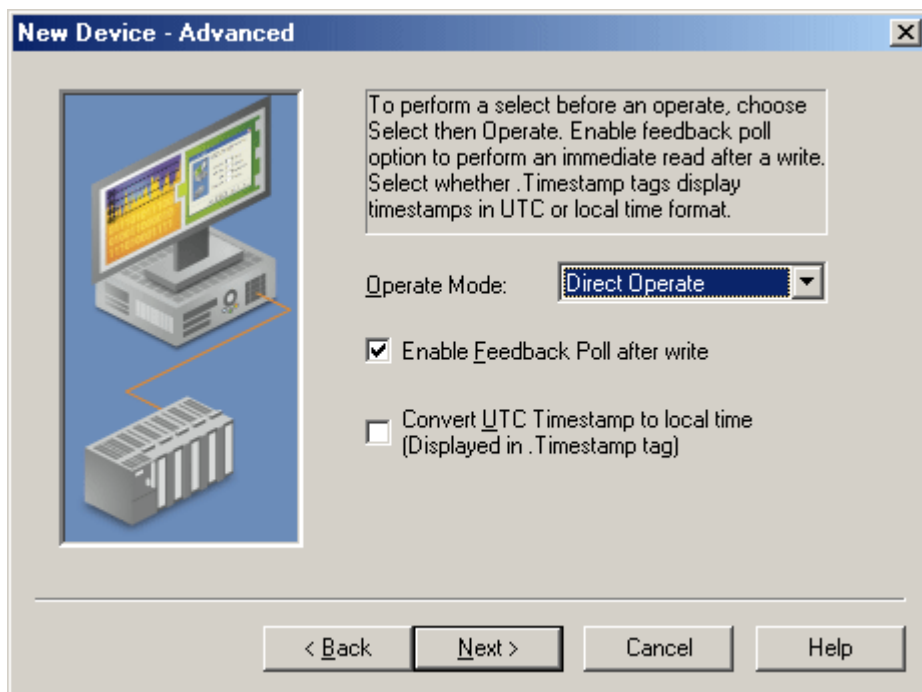

Descriptions of the parameters are as follows:

- **Operate Mode:** This parameter determines whether the writable I/O points (obj. 10 binary outputs and obj. 40 analog outputs) will use the Direct Operate or Select then Operate sequence. The default selection is Direct Operate.

Note: Individual tags' write behavior can override this setting by writing a Boolean TRUE to the output's corresponding .DO or .SO sub-type tags. For more information, refer to [DNP DO and SO subtypes](#).
- **Enable Feedback Poll after write:** When checked, this parameter will enable a feedback poll to occur after a write. The default setting is checked.
- **Convert UTC Timestamp to local time:** When checked, this parameter will convert the UTC timestamp to local time. It will be displayed in .Timestamp tags. The default setting is unchecked.

Timing and Other Considerations

Suggested Time Settings

Since the DNP3 protocol keeps communications at a minimum, the following suggested settings will help the OPC server and driver operate efficiently.

1. Only one transaction can be handled on the communications channel at a time. In situations where multiple devices share a single communications channel, the driver must move from one device to the next as quickly as possible in order to gather information at an effective rate. As more devices are added (or more information is requested from a device), the overall update rate will begin to suffer.

Note: An unresponsive device will block the other devices on that channel from receiving service while the Channel Response Timeout elapses. The explicit requests to the devices will slow down, and the event poll intervals will be affected once one or more devices fail to respond.

2. The entire send and receive transaction for a device must complete within the Device Request Timeout. If the send is successful, the response must be received within the Channel Response Timeout. The Device Request Timeout should be greater than or equal to the Channel Response Timeout.
3. Timeouts should be set to accommodate the responsiveness of a particular slave device: they should not be set too low. For example, if the Device Request Timeout and/or Channel Response Timeout were set to zero, the driver would be perpetually timed out and all effective communication would cease. Under these circumstances, users would likely receive event log error messages such as "Device '<device name>' is not responding". To

determine the best settings for the Channel Response Timeout and the Device Request Timeout, consider the following example:

There is one communications channel for 10 devices, and 9 of them are offline. Each device will wait the duration of the Channel Response Timeout (default setting 10 seconds), which will block the other devices. In order to keep the tenth device from failing due to the Device Request Timeout (default setting 30 seconds), the Device Request Timeout must be longer than it takes all of the offline devices to timeout one at a time. In this situation, a Device Request Timeout of 100 seconds should allow the tenth device to successfully complete its send and receive transaction after the nine devices timed out.

4. A poll interval that is shorter than the timeout may also cause a delay in event polling. In this case, the event poll will occur as soon as the timeout has elapsed and the device is serviced. Once the failing device starts communicating again, the event poll intervals will return to the defined rates.
5. Object 50 is the slave's clock. Since it cannot be received in event polls or through unsolicited messages, the DNP Master driver must explicitly request a read. Furthermore, because it is a time datum, the driver will request a read every time the tag is pulled for an update. On a default instantiation, that is every 200 ms. To avoid congesting the communications link, create a separate OPC group for the object 50 time tag and then set that group's update rate to 1000 ms or slower. For more information on all objects, refer to [Object Definitions](#).

Effects of DNP Devices Going Offline

When a device goes offline, it may disrupt the DNP communications for all devices using the same channel. This is because DNP is a synchronous protocol; meaning, it requires an acknowledgement, timeout, or confirmed failure for the current command before the next command in the queue may be transmitted. The OPC driver will often queue multiple commands within a typical DNP timeout period. The DNP stack must dispose of these commands in the order they are received. Outstanding commands for still-responsive slave devices can be blocked until the command queue empties. For more examples of offline scenarios, refer to "Suggested Time Settings" above.

Note: Devices that have gone offline will cause a delay in the shutdown of the OPC server while the server waits for timeouts to expire.

Modem Setup

This driver supports modem functionality. For more information, please refer to the topic "Modem Support" in the OPC Server Help documentation.

Data Types Description

Data Type	Description
Boolean	Single bit
Word	Unsigned 16 bit value bit 0 is the low bit bit 15 is the high bit
Short	Signed 16 bit value bit 0 is the low bit bit 14 is the high bit bit 15 is the sign bit
DWord	Unsigned 32 bit value bit 0 is the low bit bit 31 is the high bit
Long	Signed 32 bit value bit 0 is the low bit bit 30 is the high bit bit 31 is the sign bit
Float	32 bit Floating point value

Double	64 bit Floating point value
String	Null terminated ASCII string

Address Descriptions

Tag Addressing

Tag addressing is of the form **OBJ.VAR.IDX.SUB**, where:

- **OBJ:** The data object group.
- **VAR:** The variation requested for the tag equates to data type. It is only applicable to .Value and .Explicit sub-types. Strings do not have a variation component.

Note: For .Value tags, the variation specified in the tag address is used to set the data type of the tag for the client's use. No request for this variation is sent to the slave. The slave should have a default event variation defined for the point and will return that variation when requested for events for the point. The slave should also have a default static variation defined for the point and will return that variation when requested for class 0 static data. This default static variation will also be returned in response to explicit requests for .Explicit tags defined with variation 0.

- **IDX:** The specific data object in a given group. For example, IDX 4 is the 5th binary input. Indexes start with 0 for each object group with multiple points. Some objects, such as Objects 50 and 60, do not have an index component.
- **SUB:** The specific attribute of the point.

See Also: [Object Definitions](#) and [Sub-Type Names](#).

Variations

Name	Object #	Variation	Data Type
Binary Inputs	1	.1 .2	Boolean Byte**
Double Bit Inputs	3	.1	Byte Bits 0 and 1(MSBit) are used to reflect all four possible states. Bits 0 and 1: 0 is Intermediate, 1 is OFF, 2 is ON, 3 is Indeterminate.
		.2	Byte Bits 6 and 7(MSBit) are used to reflect all four possible states. Bits 6 and 7 : 0 is Intermediate, 1 is OFF, 2 is ON, 3 is Indeterminate. Bits 0 to 5**
Binary Outputs	10	.1 .2	Boolean Byte**
Counters	20	.1 & .5 .2 & .6	DWord Word
Frozen Counters	21	.1, .5 & .9 .2, .6 & .10	DWord Word
Analog Inputs	30	.1 & .3 .2 & .4 .5 .6	Long Short Float Double
Analog Inputs Deadband	34	.1 .2 .3	Word DWord Float
Analog Outputs	40	.1 .2 .3 .4	Long Short Float Double

Time and Date	50	.0 .1	Date Date
Class Poll Data Request	60	.1 .2 .3 .4	Boolean Boolean Boolean Boolean
Internal Indicators	80	.0 .1	Word Word

*For more information on Object 50, refer to [Object Definitions](#).

**Bits are used in order to provide Status.

Sub-Type Names

Value	The current value of the point. The data type returned from the slave depends on the default event variation and the default static variation configured in the slave for the point. The data type exposed to the client depends on the variation part of the tag address.
Explicit*	Current value of the point. Data type varies as determined by which variation is selected. Unlike the Value sub-type, reading a tag with the Explicit sub-type will cause the driver to initiate a DNP Read transaction.
TimeStamp	Time of last update from slave (when configured to report time) as T_DATE.
Online	Boolean: True if the slave is online.
Restart	Boolean: True if slave has been restarted.
Lost	Boolean: True if communications with this point were lost.
RemoteForce	Boolean: True if point value is forced to its current state at a device other than the end device.
LocalForce	Boolean: True if point value is forced to its current state at the end device. This has not yet implemented.
Chatter	Boolean: True if the slave's chatter filter is activated and applying correction.
Reference Check	Boolean: True if the reference signal used to digitize the analog input is not stable and the resulting digitized value may not be correct.
Over-range	Boolean: True if the digitized signal or calculation has exceeded its range. The actual value field can be ignored as its value is not defined.
DO**	Boolean: True if a writable point is set to Direct Operate mode. Writing to a tag of this sub-type will override the global Operate Mode setting. For more information, refer to Operate Mode .
SO**	Boolean: True if a writable point is set to Select then Operate mode. Writing to a tag of this sub-type will override the global Operate Mode setting. For more information, refer to Operate Mode .
Flags	Full set of transaction flags (0 through 7) for the specified DNP point.***

Operate	<p>This more limited functionality is only retained to support older projects. New projects should use the enhanced Operate commands shown below.****</p> <p>The user specifies a crafted value to write. The .Operate sub-type is implemented as a DWord, but currently only the lowest 8 bits are significant. Bits 0-3 form a command number. Allowable values are currently 0-4. Values outside this range result in a failed write. The commands are as follows:</p> <p>0 - No operation. 1 - Pulse on. 2 - Pulse off. 3 - Latch on (same as writing a 1 to 10.x.x.Value). 4 - Latch off (same as writing a 0 to 10.x.x.Value).</p> <p>Bit 4 is the Queue command modifier. Bit 5 is the Clear command modifier.</p> <p>Bits 6 & 7 form a Trip-Close command pair. Allowable values are currently 0-2. Values outside this range result in a failed write.</p> <p>Bit 6 is the Paired Close command modifier. Bit 7 is the Paired Trip command modifier.</p> <p>The allowable commands are as follows: 0- NUL 1- CLOSE 2- TRIP</p>
---------	--

*DNP is usually used in a report-by-exception model, where the DNP slave device responds to an Event Poll with the point data that has changed since the last report. Some DNP slave devices, however, may have I/O points that are not configured to answer to Event or Integrity polls. These points require special handling via the .Explicit sub-type. The .Explicit sub-type will trigger a DNP read transaction for every tag update. This can potentially cause a great deal of traffic on the DNP bus. Tags using the .Explicit sub-type must use a suitable update rate. Rates of 1000 ms or longer are recommended, as is limiting the use of .Explicit tags to only where required. It is the user's responsibility to configure .Explicit tags appropriately.

**Direct Operate (DO) and Select-then-Operate (SO) subtypes apply only to objects 10 and 40. DO and SO are not allowed for other objects.

*****See Also:** [DNP Addressing / DNP Object Flag Definitions](#).

******See Also:** [DNP Advanced Operations](#).

Enhanced Operate Commands

Enhanced Operate Controls	These expanded Operate sub-types allow a user to completely control commands sent to a Control Relay Output Block.*
Operate.OpType	<p>This Byte contains the specific operation type to perform. The commands are as follows:</p> <p>0 - No operation. 1 - Pulse on. 2 - Pulse off. 3 - Latch on (same as writing a 1 to 10.x.x.Value). 4 - Latch off (same as writing a 0 to 10.x.x.Value).</p>
Operate.TripCloseCode	<p>This Byte contains the Trip-Close code to apply to the operation. The commands are as follows:</p> <p>0 - No operation. 1 - Close. 2 - Trip.</p>
Operate.Clear	This Boolean adds the 'Clear' attribute to the command.
Operate.OnTime	This DWord specifies the on-time in milliseconds for the command.
Operate.OffTime	This DWord specifies the off-time in milliseconds for the command.
Operate.FeedbackDelay	This DWord specifies the time in milliseconds before a feedback poll is performed after the command completes.

Operate.Set	After all of the parameters above have been written, writing a TRUE to this Boolean will initiate the command.
-------------	--

***See Also:** [DNP Advanced Operations](#).

Special Tags

Warmrestart	When a Boolean TRUE is written to this tag, a warm restart will be sent to the slave device. The tag will read back as zero or FALSE.
Coldrestart	When a Boolean TRUE is written to this tag, a cold restart will be sent to the slave device. The tag will read back as zero or FALSE.
unsolreceived	When written as a DWord TRUE, the tag will increment by 1 every time an unsolicited message is received from the slave. Note that this tag is read/write, so it can be reset to any value by the operator.

Internal Tags

Tag	Description	Data Type	Access
_DeviceRequestQueueDepth	This tag indicates the current depth of the queue used for storing device requests. It is useful for diagnostic purposes for issues such as tag update delays. Although a zero or steady value is expected, a non-zero value is not a problem unless it continues to grow and causes a delay in tag updates. For example, if the project has a device defined with 100 blocks of .Explicit tags and the _DeviceRequestQueueDepth tag value is 100, then something is blocking the tags from being updated on time.	DWord	Read Only
_MasterAddress	This tag allows the Master Address device property to be changed on the fly. Valid values range from 0 to 65519.	DWord	Read/Write
_SlaveAddress	This tag allows the Slave Address device property to be changed on the fly. Valid values range from 0 to 65519.	DWord	Read/Write

DNP Addressing

This topic provides additional information about the OBJ.VAR.IDX.SUB addressing format. Values reported to the server from the slave device will be in the slave device's default variation (which may differ from the server default variation) and will be obtained through report by exception. More information on the attributes is as follows:

- For the .SUB Value attribute, the data type is designated by the variation (.VAR). If the variation is .0, the .SUB Value attribute will have the same data type as the default variation.
- For the .SUB Flags attributes contained within the Flags attribute, the data type is always Boolean. They are unaffected by the variation.
- For the .SUB Flags attribute, the data type is always byte and unaffected by the variation.
- The .SUB TimeStamp attribute is always in Date format, and is also unaffected by the variation selected.

Note: The default variation for each object group is shown in **bold**.

Address OBJ.VAR.IDX Attributes	Address .SUB Attribute	Data Type	Access
Binary Inputs			
1.{0,1,2}.{0-65535}	Chatter, LocalForce, Lost, Online, RemoteForce, Restart	Boolean	Read Only
1.{0,1,2}.{0-65535}	Flags*	Byte	Read Only
1.{0,1,2}.{0-65535}	TimeStamp	Date	Read Only
1.0.{0-65535}	Value, Explicit	Boolean	Read Only
1.1.{0-65535}	Value , Explicit	Boolean	Read Only
1.2.{0-65535} (with Status)	Value, Explicit	Byte	Read Only
Double Bit Inputs			
3.{0,1,2}.{0-65535}	Chatter, LocalForce, Lost, Online,	Boolean	Read Only

	RemoteForce, Restart		
3.{0,1,2}.{0-65535}	Flags*	Byte	Read Only
3.{0,1,2}.{0-65535}	TimeStamp	Date	Read Only
3.0.{0-65535}	Value, Explicit	Byte	Read Only
3.1.{0-65535}	Value, Explicit	Byte	Read Only
3.2.{0-65535} (with Status)	Value, Explicit	Byte	Read Only
Binary Outputs			
10.{0,1,2}.{0-65535}	LocalForce, Lost, Online, RemoteForce, Restart	Boolean	Read Only
10.{0,1,2}.{0-65535}	DO, SO	Boolean	Read/Write
10.{0,1,2}.{0-65535}	Operate.Set, Operate.Clear**	Boolean	Read/Write
10.{0,1,2}.{0-65535}	Operate.OpType, Operate.TripCloseCode**	Byte	Read/Write
10.{0,1,2}.{0-65535}	Operate.OnTime, Operate.OffTime, Operate.FeedbackDelay**	DWord	Read/Write
10.{0,1,2}.{0-65535}	Flags*	Byte	Read Only
10.{0,1,2}.{0-65535}	TimeStamp	Date	Read Only
10.0.{0-65535}	Value, Explicit	Boolean	Read/Write
10.1.{0-65535}	Value, Explicit	Boolean	Read/Write
10.2.{0-65535} (with Status)	Value, Explicit	Byte	Read Only
Counters			
20.{0,1,2,5,6}.{0-65535}	LocalForce, Lost, Online, RemoteForce, Restart	Boolean	Read Only
20.{0,1,2,5,6}.{0-65535}	Flags*	Byte	Read Only
20.{0,1,2,5,6}.{0-65535}	TimeStamp	Date	Read Only
20.0.{0-65535}	Value, Explicit	DWord	Read Only
20.1.{0-65535} (with Flag)(*1)	Value, Explicit	DWord	Read Only
20.2.{0-65535} (with Flag)(*1)	Value, Explicit	Word	Read Only
20.5.{0-65535}	Value, Explicit	DWord	Read Only
20.6.{0-65535}	Value, Explicit	Word	Read Only
Frozen Counters			
21.{0,1,2,5,6,9,10}.{0-65535}	LocalForce, Lost, Online, RemoteForce, Restart	Boolean	Read Only
21.{0,1,2,5,6,9,10}.{0-65535}	Flags*	Byte	Read Only
21.{0,1,2,5,6,9,10}.{0-65535}	TimeStamp	Date	Read Only
21.0.{0-65535}	Value, Explicit	DWord	Read Only
21.1.{0-65535} (with Flag)(*1)	Value, Explicit	DWord	Read Only
21.2.{0-65535} (with Flag)(*1)	Value, Explicit	Word	Read Only
21.5.{0-65535} (with Time of Freeze)(*2)	Value, Explicit	DWord	Read Only
21.6.{0-65535} (with Time of Freeze)(*2)	Value, Explicit	Word	Read Only
21.9.{0-65535}	Value, Explicit	DWord	Read Only
21.10.{0-65535}	Value, Explicit	Word	Read Only
Analog Inputs			
30.{0,1,2,3,4,5,6}.{0-65535}	LocalForce, Lost, Online, RemoteForce, Restart, OverRange, ReferenceCheck	Boolean	Read Only
30.{0,1,2,3,4,5,6}.{0-65535}	Flags*	Byte	Read Only
30.{0,1,2,3,4,5,6}.{0-65535}	TimeStamp	Date	Read Only
30.0.{0-65535}	Value, Explicit	Double	Read Only

30.1.{0-65535} (with Flag)(*1)	Value, Explicit	Long	Read Only
30.2.{0-65535} (with Flag)(*1)	Value, Explicit	Short	Read Only
30.3.{0-65535}	Value, Explicit	Long	Read Only
30.4.{0-65535}	Value, Explicit	Short	Read Only
30.5.{0-65535}	Value, Explicit	Float	Read Only
30.6.{0-65535}	Value, Explicit	Double	Read Only
Analog Inputs Deadband			
34.0.{0-65535}	Value, Explicit	DWord	Read/Write
34.1.{0-65535}	Value, Explicit	Word	Read/Write
34.2.{0-65535}	Value, Explicit	DWord	Read/Write
34.3.{0-65535}	Value, Explicit	Float	Read/Write
Analog Outputs			
40.{0,1,2,3,4}.{0-65535}	LocalForce, Lost, Online, RemoteForce, Restart, OverRange, ReferenceCheck	Boolean	Read Only
40.{0,1,2,3,4}.{0-65535}	DO, SO	Boolean	Read/Write
40.{0,1,2,3,4}.{0-65535}	Flags*	Byte	Read Only
40.{0,1,2,3,4}.{0-65535}	TimeStamp	Date	Read Only
40.0.{0-65535}	Value, Explicit	Double	Read/Write
40.1.{0-65535}	Value, Explicit	Long	Read/Write
40.2.{0-65535}	Value, Explicit	Short	Read/Write
40.3.{0-65535}	Value, Explicit	Float	Read/Write
40.4.{0-65535}	Value, Explicit	Double	Read/Write
Time and Date			
50.0 OBJ.VAR(*4)	Value, Explicit	Date	Read Only
50.1 OBJ.VAR(*4)	Value, Explicit	Date	Read Only
Class Poll Data Request			
60.{1}(*3)	Value, Explicit	Boolean	Read/Write
60.{2}(*3)	Value, Explicit	Boolean	Read/Write
60.{3}(*3)	Value, Explicit	Boolean	Read/Write
60.{4}(*3)	Value, Explicit	Boolean	Read/Write
Internal Indications			
80.{0}	Value, Explicit***	Word	Read Only
80.{1}	Value, Explicit***	Word	Read Only
Octet String Object			
110.{0-65535} OBJ.IDX	Value, Explicit - will take up to 254 chars.	String	Read/Write

(*1) Certain object variations in the DNP3 protocol are specified to return multiple data items. For example, object 21.5 asks for a frozen counter's value, along with the time of freeze. Because the OPC interface does not handle complex data types, such information is not available with a single tag. The multi-data variations can be specified, but OPC will need to retrieve the various parts of the combined report (e.g., counter value and time of freeze) in separate tags.

(*2) Time of Freeze is not currently supported.

(*3) These tags trigger commands on the DNP slave device when a TRUE value is written. They read back as zero or FALSE.

(*4) Regarding Object 50, refer to [Object Definitions](#).

*See Also: [DNP Object Flag Definitions](#).

**See Also: [DNP Advanced Operations](#).

***See Also: [IIN Definitions](#).

DNP Object Flag Definitions

In the DNP object flag definitions, bits 0 through 4 are the same for all objects. Bits 5 through 7 are object-dependent and may only be reported if the DNP slave's default variation for that object includes flags. For example, object 20's

variations 1-4 include flags, whereas 5-8 do not. The DNP slave configuration defines the default variation and may not be configurable in some slaves.

Object 1 - Binary Inputs	0: Online 1: Restart 2: Communications Lost 3: Remote Force 4: Local force 5: Chatter 6: Reserved 7: State (Status of Input)
Object 3 - Double Bit Inputs	0: Online 1: Restart 2: Communications Lost 3: Remote Force 4: Local force 5: Chatter 6: State (Status of Input) 7: State (Status of Input)
Object 10 - Binary Outputs	0: Online 1: Restart 2: Communications Lost 3: Remote Force 4: Local force 5: Reserved 6: Reserved 7: State (Status of Input)
Object 20 - Counters Object 21 - Frozen Counters	0: Online 1: Restart 2: Communications Lost 3: Remote Force 4: Local force (or rollover) 5: Reserved 6: Reserved 7: Reserved
Object 30 - Analog Inputs	0: Online 1: Restart 2: Communications Lost 3: Remote Force 4: Local force 5: Overrange 6: Reference Check 7: Reserved
Object 34 - Analog Inputs Deadband	0: Online 1: Restart 2: Communications Lost 3: Remote Force 4: Local force 5: Reserved 6: Reserved 7: Reserved
Object 40 - Analog Outputs	0: Online 1: Restart 2: Communications Lost 3: Remote Force 4: Local force 5: Overrange 6: Reference Check 7: Reserved
Object 50 - Time and Date	Flags do not Apply
Object 60 - Class Poll Data Request	Flags do not Apply
Object 80 - Internal Indications	Flags do not Apply

Object 110 - Octet String Object	0: Online 1: Restart 2: Communications Lost 3: Remote Force 4: Reserved 5: Reserved 6: Reserved 7: Reserved
----------------------------------	--

Object Definitions

The valid objects for DNP Master Serial addressing are defined in the tables below. Note that all objects' status are retained on every transaction; all status flags are reported in their sub-type tags. For variation defaults, refer to the specific DNP3 slave device's documentation. For more information, refer to [Address Descriptions](#) and [DNP Addressing](#).

Object Number	Variation Number	Description
1	0	Binary Input Any Variation.
1	1	Binary Input.
1	2	Binary Input with Status.
3	0	Double Bit Input Any Variation.
3	1	Double Bit Input.
3	2	Double Bit Input with Status.
10	0	Binary Output Status Any Variation.
10	1	Binary Output.
10	2	Binary Output Status.
20	0	Binary Counter Any Variation.
20	1	32-Bit Binary Counter (with Flag).
20	2	16-Bit Binary Counter (with Flag).
20	5	32-Bit Binary Counter without Flag.
20	6	16-Bit Binary Counter without Flag.
21	0	Frozen Counter Any Variation.
21	1	32-Bit Frozen Counter (with Flag).
21	2	16-Bit Frozen Counter (with Flag).
21	5	32-Bit Frozen Counter with Time Of Freeze.**
21	6	16-Bit Frozen Counter with Time Of Freeze.**
21	9	32-Bit Frozen Counter without Flag.
21	10	16-Bit Frozen Counter without Flag.
30	0	Analog Input - Any Variation.
30	1	32-Bit Analog Input.
30	2	16-Bit Analog Input.
30	3	32-Bit Analog Input without Flag.
30	4	16-Bit Analog Input without Flag.
30	5	Short floating point.
30	6	Long floating point.
34	0	Analog Input Deadband (Variation 0 is used to request default variation).
34	1	16 bit Analog Input Deadband.
34	2	32 bit Analog Input Deadband.
34	3	Short Floating Point Analog Input Deadband.

40	0	Analog Output Status (Variation 0 is used to request default variation).
40	1	32-Bit Analog Output Status.
40	2	16-Bit Analog Output Status.
40	3	Short floating point Analog Output Status.
40	4	Long floating point Analog Output Status.
50*	0	Time and Date.
50*	1	Time and Date.
60***	1	Initiates a poll of DNP Class 0 data.
60***	2	Initiates a poll of DNP Class 1 data.
60***	3	Initiates a poll of DNP Class 2 data.
60***	4	Initiates a poll of DNP Class 3 data.
80	0	The default variation 0 is acceptable. ****
80	1	DNP Internal Indication bits (IIN) as an unsigned short integer.****
110	String Length	Octet String Object.

*Object 50 is the slave's clock. It can't be read through unsolicited replies, so the DNP Master Serial driver must explicitly request a read. And because it's a time datum, the driver will request a read every time the tag is pulled for an update. On a default instantiation, that is every 200ms. To avoid congesting the communications link, create a separate OPC group for the object 50 time tag and set that group's update rate to 1000 ms or slower.

**Time of Freeze is currently not supported.

***Object 60 variations 1-4 (i.e., DNP Class 0-3): writing a Boolean TRUE to these tags will initiate the read operation. Reading these tags always returns a Boolean FALSE with good quality.

****For more information, refer to [IIN Definitions](#).

Objects with Values Reflected in Other Objects

Certain objects are not used in the driver due to the fact that their values are reflected in other objects.

Object	Name	Reflected in Object	Name
2	Binary Input Change Event	1	Binary Input State
4	Double Bit Input Change Event	3	Double Bit Input State
11	Binary Output Change Event	10	Binary Output State
12	Control Relay Output Block	10	Binary Output State
13	Binary Output Command Event	10	Binary Output State
22	Counter Event Change	20	Counter Value
23	Frozen Counter Event Change	21	Frozen Counter Value
32	Analog Input Change Event	30	Analog Input Value
41	Analog Output Write	40	Analog Output Value
42	Analog Output Change Event	40	Analog Output Value
43	Analog Output Command Event	40	Analog Output Value
51	Time and Date CTO*	50	Time and Date
111	Octet String Event Change	110	Octet String Value

*Common Time of Occurrence.

IIN Definitions

Object 80 returns the DNP Internal Indication bits (IIN) as an unsigned short integer. The data are refreshed with each response from the DNP slave and therefore represent the latest IIN report.

Internal Indication	Bit Mask	Reason
DNPDEFS_IIN_RESTART	0x8000	Slave has been restarted.
DNPDEFS_IIN_TROUBLE	0x4000	Slave is reporting trouble.
DNPDEFS_IIN_LOCAL	0x2000	Slave is running in local mode.
DNPDEFS_IIN_NEED_TIME	0x1000	Slave requires time synchronization.
DNPDEFS_IIN_CLASS_3	0x0800	Slave has Class 3 data available.
DNPDEFS_IIN_CLASS_2	0x0400	Slave has Class 2 data available.
DNPDEFS_IIN_CLASS_1	0x0200	Slave has Class 1 data available.
DNPDEFS_IIN_ALL_STATIONS	0x0100	The message was directed to the DNP broadcast address.
DNPDEFS_IIN_BAD_CONFIG	0x0020	Slave is misconfigured.
DNPDEFS_IIN_ALREADY_EXECUTING	0x0010	Slave has received a duplicate request.
DNPDEFS_IIN_BUFFER_OVFL	0x0008	Slave has lost one or more event reports.
DNPDEFS_IIN_OUT_OF_RANGE	0x0004	Command received references a non-existent I/O point.
DNPDEFS_IIN_OBJECT_UNKNOWN	0x0002	Command received references an unknown object.
DNPDEFS_IIN_BAD_FUNCTION	0x0001	Command received is not supported.

DNP Advanced Operations

The DNP Object 10 (Binary Outputs) actually includes Object 12, which is used to write operations to the Control Relay Output Block. If all that is needed is a simple LATCH_ON or LATCH_OFF action, writing a Boolean true or false to 10.0.0.Value will suffice. If the DNP application requires more fine-grained control over the operation of a Control Relay, the following sub-types are available.

- 10.x.x.Operate.Clear
- 10.x.x.Operate.OpType
- 10.x.x.Operate.TripCloseCode
- 10.x.x.Operate.OnTime
- 10.x.x.Operate.OffTime
- 10.x.x.Operate.FeedbackDelay
- 10.x.x.Operate.Set

To perform a crafted operation using these sub-type tags, populate each of the tags with the value required for the operation.

- **Operate.OpType** may be one of NUL (0), PULSE_ON (1), PULSE_OFF (2), LATCH_ON (3) or LATCH_OFF (4).
- **Operate.TripCloseCode** may be one of NUL (0), CLOSE (1) or TRIP (2).
- **Operate.OnTime**, **Operate.OffTime** and **Operate.FeedbackDelay** are all set in milliseconds. Operate.FeedbackDelay determines how long after the operation the DNP driver will ask the device to report its new settings. If the "Automatically perform feedback poll after write" option is disabled in the driver properties, this tag will have no effect. Not all combinations of OpType and TripCloseCode are interoperable. The DNP driver can prevent some of these non-interoperable combinations, but not all. Consult the documentation for the DNP device to determine which operation codes are supported.

After all the component values for the operate command have been set, write a TRUE to **Operate.Set**.

Note: A complete description of the Object 12 operation codes is beyond the scope of this help file. For complete information, consult the DNP3 Technical Standard, Volume 6, Part 2.

Error Descriptions

The following error/warning messages may be generated. Click on the link for a description of the message.

Address Validation

[Address '<address>' is not valid on device '<channel>' '<device>'](#)
[Address '<address>' is out of range for the specified device or register](#)
[Data type '<type>' is not valid for device address '<address>'](#)
[Device address '<address>' contains a syntax error](#)
[Device address '<address>' is Read Only](#)

Device Status Messages

[Device '<device>' does not support the LAN Time Sync Style Record Current Time Function Code 24](#)
[Device '<device>' indicated an event buffer overflow \(IIN 2.3\)](#)
[Device '<device>' Restarting](#)
[Device '<device name>' is not responding](#)
[Reached Max Events Per Point for Object Group '<object group>' Point '<data index>' on Device '<device>'](#)
[Unable to read point\(s\) '<OBJ.VAR.IDX>' on device '<device>'. Failed to initialize communication stack](#)
[Unable to read point\(s\) '<OBJ.VAR.IDX>' on device '<device>'. Internal Error occurred](#)
[Unable to read point\(s\) '<OBJ.VAR.IDX – OBJ.VAR.IDX>' on device '<device>'. Failed to initialize communication stack](#)
[Unable to read point\(s\) '<OBJ.VAR.IDX – OBJ.VAR.IDX>' on device '<device>'. Internal Error occurred](#)
[Unable to receive entire poll response from device '<device>' within Response Timeout. Increase Response Timeout to resolve](#)
[Unable to write to '<address>' on device '<device>'. Failed to initialize communication stack](#)
[Unable to write to '<address>' on device '<device>'. Internal Error occurred](#)

DNP Specific Error Messages

Read Errors

[Unable to read point\(s\) '<OBJ.VAR.IDX>' on device '<device>'. An abnormal condition exists in the device \(IIN1.6\)](#)
[Unable to read point\(s\) '<OBJ.VAR.IDX>' on device '<device>'. Device detected corrupt configuration \(IIN2.5\)](#)
[Unable to read point\(s\) '<OBJ.VAR.IDX>' on device '<device>'. Device does not support a point in the range or other parameter error \(IIN2.2\)](#)
[Unable to read point\(s\) '<OBJ.VAR.IDX>' on device '<device>'. Device does not support requested operation for objects in the request \(IIN2.1\)](#)
[Unable to read point\(s\) '<OBJ.VAR.IDX>' on device '<device>'. Device does not support the function code \(IIN2.0\)](#)
[Unable to read point\(s\) '<OBJ.VAR.IDX>' on device '<device>'. Device reports that some output points are in local mode \(IIN1.5\)](#)
[Unable to read point\(s\) '<OBJ.VAR.IDX>' on device '<device>'. Device reports that the operation is already executing \(IIN2.4\)](#)
[Unable to read point\(s\) '<OBJ.VAR.IDX>' on device '<device>'. Response missing data](#)
[Unable to read point\(s\) '<OBJ.VAR.IDX>' on device '<device>'. Session shutting down or duplicate request](#)
[Unable to read point\(s\) '<OBJ.VAR.IDX>' on device '<device>'. Unrecognized Object returned in Response](#)
[Unable to read point\(s\) '<OBJ.VAR.IDX – OBJ.VAR.IDX>' on device '<device>'. An abnormal condition exists in the device \(IIN1.6\)](#)
[Unable to read point\(s\) '<OBJ.VAR.IDX – OBJ.VAR.IDX>' on device '<device>'. Device detected corrupt configuration \(IIN2.5\)](#)
[Unable to read point\(s\) '<OBJ.VAR.IDX – OBJ.VAR.IDX>' on device '<device>'. Device does not support a point in the range or other parameter error \(IIN2.2\)](#)
[Unable to read point\(s\) '<OBJ.VAR.IDX – OBJ.VAR.IDX>' on device '<device>'. Device does not support requested operation for objects in the request \(IIN2.1\)](#)
[Unable to read point\(s\) '<OBJ.VAR.IDX – OBJ.VAR.IDX>' on device '<device>'. Device does not support the function code \(IIN2.0\)](#)
[Unable to read point\(s\) '<OBJ.VAR.IDX – OBJ.VAR.IDX>' on device '<device>'. Device reports that some output points are in local mode \(IIN1.5\)](#)

[Unable to read point\(s\) '<OBJ.VAR.IDX – OBJ.VAR.IDX>' on device '<device>'. Device reports that the operation is already executing \(IIN2.4\)](#)

[Unable to read point\(s\) '<OBJ.VAR.IDX – OBJ.VAR.IDX>' on device '<device>'. Response missing data](#)

[Unable to read point\(s\) '<OBJ.VAR.IDX – OBJ.VAR.IDX>' on device '<device>'. Session shutting down or duplicate request](#)

[Unable to read point\(s\) '<OBJ.VAR.IDX – OBJ.VAR.IDX>' on device '<device>'. Unrecognized Object returned in Response](#)

Write Errors

[Unable to write to '<address>' on device '<device>'. An abnormal condition exists in the device \(IIN1.6\)](#)

[Unable to write to '<address>' on device '<device>'. Control-Related Status Code '<status code>'](#)

[Unable to write to '<address>' on device '<device>'. Device detected corrupt configuration \(IIN2.5\)](#)

[Unable to write to '<address>' on device '<device>'. Device does not support a point in the range or other parameter error \(IIN2.2\)](#)

[Unable to write to '<address>' on device '<device>'. Device does not support requested operation for objects in the request \(IIN2.1\)](#)

[Unable to write to '<address>' on device '<device>'. Device does not support the function code \(IIN2.0\)](#)

[Unable to write to '<address>' on device '<device>'. Device reports that some output points are in local mode \(IIN1.5\)](#)

[Unable to write to '<address>' on device '<device>'. Device reports that the operation is already executing \(IIN2.4\)](#)

[Unable to write to '<address>' on device '<device>'. Select Operate response invalid](#)

[Unable to write to '<address>' on device '<device>'. Session shutting down or duplicate request](#)

[Unable to write to '<address>' on device '<device>'. Unrecognized Object returned in Response](#)

[Unable to write to '<address>' on device '<device>'. Unsupported Operation Type](#)

[Unable to write to '<address>' on device '<device>'. Unsupported Trip-Close Code](#)

[Unable to write to '<address>' on device '<device>'. Write value specified is invalid](#)

[Unable to write to address '<master address>' on device '<device>'. Master Address must be between '<min master address>' and '<max master address>'](#)

[Unable to write to address '<slave address>' on device '<device>'. Slave Address must be between '<min slave address>' and '<max slave address>'](#)

Address Validation

The following error/warning messages may be generated. Click on the link for a description of the message.

Address Validation

[Address '<address>' is not valid on device '<channel>' '<device>'](#)

[Address '<address>' is out of range for the specified device or register](#)

[Data type '<type>' is not valid for device address '<address>'](#)

[Device address '<address>' contains a syntax error](#)

[Device address '<address>' is Read Only](#)

Address '<address>' is not valid on device '<channel>' '<device>'

Error Type:

Warning

Possible Cause:

A scan tag with an invalid address was sent to the driver for initialization.

Solution:

Correct the address in the invalid tag.

Address '<address>' is out of range for the specified device or register

Error Type:

Warning

Possible Cause:

A tag address that has been specified statically references a location that is beyond the range of supported locations for the device.

Solution:

Verify that the address is correct; if it is not, re-enter the address in the client application.

Data type '<type>' is not valid for device address '<address>'

Error Type:

Warning

Possible Cause:

A tag address that has been specified statically has been assigned an invalid data type.

Solution:

Modify the requested data type in the client application.

Device address '<address>' contains a syntax error

Error Type:

Warning

Possible Cause:

A tag address that has been specified statically contains one or more invalid characters.

Solution:

Re-enter the address in the client application.

Device address '<address>' is Read Only

Error Type:

Warning

Possible Cause:

A tag address that has been specified statically has a requested access mode that is not compatible with what the device supports for that address.

Solution:

Change the access mode in the client application.

Device Status Messages

The following error/warning messages may be generated. Click on the link for a description of the message.

Device Status Messages

[Device '<device>' does not support the LAN Time Sync Style Record Current Time Function Code 24](#)

[Device '<device>' indicated an event buffer overflow \(IIN 2.3\)](#)

[Device '<device>' Restarting](#)

[Device '<device name>' is not responding](#)

[Reached Max Events Per Point for Object Group '<object group>' Point '<data index>' on Device '<device>'](#)

[Unable to read point\(s\) '<OBJ.VAR.IDX>' on device '<device>'. Failed to initialize communication stack](#)

[Unable to read point\(s\) '<OBJ.VAR.IDX>' on device '<device>'. Internal Error occurred](#)

[Unable to read point\(s\) '<OBJ.VAR.IDX – OBJ.VAR.IDX>' on device '<device>'. Failed to initialize communication stack](#)

[Unable to read point\(s\) '<OBJ.VAR.IDX – OBJ.VAR.IDX>' on device '<device>'. Internal Error occurred](#)

[Unable to receive entire poll response from device '<device>' within Response Timeout. Increase Response Timeout to resolve](#)

[Unable to write to '<address>' on device '<device>'. Failed to initialize communication stack](#)

[Unable to write to '<address>' on device '<device>'. Internal Error occurred](#)

Device '<device>' does not support the LAN Time Sync Style Record Current Time Function Code 24

Error Type:

Warning

Possible Cause:

The device does not support LAN (function code 24) which is the specified time synchronization method.

Solution:

Locate the **Communications** tab in **Device Properties**, and then change the time synchronization setting to Serial.

Note:

Time synchronization will be successful despite the error message. In order to prevent the error message from occurring, change the setting as described above.

Device '<device>' indicated an event buffer overflow (IIN 2.3)

Error Type:

Warning

Possible Cause:

A response from the device included IIN bytes along with the bit set, indicating that an event buffer overflow condition exists. At least one unconfirmed event was lost because the event buffers did not have enough room to store the information.

Solution:

1. If many events occur between event polls (and the bit is being set by the slave) decrease the event poll interval to keep the buffer size small.
2. To avoid logging unnecessary events, adjust the analog point deadband.

See Also:

[Event Playback](#)

Device '<device>' Restarting

Error Type:

Information

Possible Cause:

The client wrote a "1" to a Warmrestart or Coldrestart tag.

Solution:

None.

Device '<device name>' is not responding

Error Type:

Serious

Possible Cause:

1. The serial connection between the device and the Host PC is broken.
2. The communications parameters for the serial connection are incorrect.
3. The named device may have been assigned an incorrect Network ID.
4. There is an improper timing setting or a non-responsive device on the channel.

Solution:

1. Verify the cabling between the DNP master and the DNP slave device.
2. Verify that the specified communications parameters match those of the device.
3. Verify that the Network ID given to the named device matches that of the actual device.

See Also:

[Timing and Other Considerations](#)

Reached Max Events Per Point for Object Group '<object group>' Point '<data index>' on Device '<device>'

Error Type:

Warning

Possible Cause:

At least one unconfirmed event was lost because the event buffers did not have enough room to store the information.

Reasons:

1. The value specified for the Max Events Per Point parameter is too small to receive all of the events without discarding data.
2. The event poll intervals are too large.
3. The slave is logging unnecessary events (such as changes in a floating value).

Solution:

1. Determine the buffer size allowed in the slave, and then set the Max Events Per Point parameter to the same value (or larger). This driver allows 10000 events per point. The default setting is 100.
2. If many events occur between event polls (and the Max Events Per Point is reached) decrease the event poll interval to keep the buffer size small.
3. To avoid logging unnecessary events, adjust the analog point deadband.

See Also:

[Event Playback](#)

Unable to read point(s) '<OBJ.VAR.IDX>' on device '<device>'. Failed to initialize communication stack

Error Type:

Fatal

Possible Cause:

The driver was unable to initialize the communication stack.

Solution:

Reinitialize the driver by right-clicking on the Administration menu and selecting **Reinitialize**. If the problem persists, restart the master.

Unable to read point(s) '<OBJ.VAR.IDX>' on device '<device>'. Internal Error occurred

Error Type:

Fatal

Possible Cause:

An internal error occurred within the driver.

Solution:

The driver may recover on its own. If the problem persists, restart the master.

Unable to read point(s) '<OBJ.VAR.IDX – OBJ.VAR.IDX>' on device '<device>'. Failed to initialize communication stack

Error Type:

Fatal

Possible Cause:

The driver was unable to initialize the communication stack.

Solution:

Reinitialize the driver by right-clicking on the Administration menu and selecting **Reinitialize**. If the problem persists, restart the master.

Unable to read point(s) '<OBJ.VAR.IDX – OBJ.VAR.IDX>' on device '<device>'. Internal Error occurred

Error Type:

Fatal

Possible Cause:

An internal error occurred within the driver.

Solution:

The driver may recover on its own. If the problem persists, restart the master.

Unable to receive entire poll response from device '<device>' within Response Timeout. Increase Response Timeout to resolve

Error Type:

Warning

Possible Cause:

The Response Timeout is too short to allow the slave's integrity or event poll response to complete in time. The slave may be returning a large number of points, but the timeout elapsed before the data could be received.

Solution:

If the slave has been configured to return a large number of points (such as during a class 0 poll) change the channel's Response Timeout to a value that will allow the response to complete successfully.

Note:

The channel's Response Timeout should be as accurate as possible, because it is also the time that the driver will wait before reporting that the device is not responding.

See Also:

[Timing and Other Considerations](#)

Unable to write to '<address>' on device '<device>'. Failed to initialize communication stack

Error Type:

Fatal

Possible Cause:

The driver was unable to initialize the communication stack.

Solution:

Reinitialize the driver by right-clicking on the Administration menu and selecting **Reinitialize**. If the problem persists, restart the master.

Unable to write to '<address>' on device '<device>'. Internal Error occurred

Error Type:

Fatal

Possible Cause:

An internal error occurred within the driver.

Solution:

The driver may recover on its own. If the problem persists, restart the master.

DNP Specific Error Messages

The following error/warning messages may be generated. Click on the link for a description of the message.

DNP Specific Error Messages

[Read Errors](#)

[Write Errors](#)

Read Errors

The following error/warning messages may be generated. Click on the link for a description of the message.

Read Errors

[Unable to read point\(s\) '<OBJ.VAR.IDX>' on device '<device>'. An abnormal condition exists in the device \(IIN1.6\)](#)

[Unable to read point\(s\) '<OBJ.VAR.IDX>' on device '<device>'. Device detected corrupt configuration \(IIN2.5\)](#)

[Unable to read point\(s\) '<OBJ.VAR.IDX>' on device '<device>'. Device does not support a point in the range or other parameter error \(IIN2.2\)](#)

[Unable to read point\(s\) '<OBJ.VAR.IDX>' on device '<device>'. Device does not support requested operation for objects in the request \(IIN2.1\)](#)

[Unable to read point\(s\) '<OBJ.VAR.IDX>' on device '<device>'. Device does not support the function code \(IIN2.0\)](#)

[Unable to read point\(s\) '<OBJ.VAR.IDX>' on device '<device>'. Device reports that some output points are in local mode \(IIN1.5\)](#)

[Unable to read point\(s\) '<OBJ.VAR.IDX>' on device '<device>'. Device reports that the operation is already executing \(IIN2.4\)](#)

[Unable to read point\(s\) '<OBJ.VAR.IDX>' on device '<device>'. Response missing data](#)

[Unable to read point\(s\) '<OBJ.VAR.IDX>' on device '<device>'. Session shutting down or duplicate request](#)

[Unable to read point\(s\) '<OBJ.VAR.IDX>' on device '<device>'. Unrecognized Object returned in Response](#)

[Unable to read point\(s\) '<OBJ.VAR.IDX – OBJ.VAR.IDX>' on device '<device>'. An abnormal condition exists in the device \(IIN1.6\)](#)

[Unable to read point\(s\) '<OBJ.VAR.IDX – OBJ.VAR.IDX>' on device '<device>'. Device detected corrupt configuration \(IIN2.5\)](#)

[Unable to read point\(s\) '<OBJ.VAR.IDX – OBJ.VAR.IDX>' on device '<device>'. Device does not support a point in the range or other parameter error \(IIN2.2\)](#)

[Unable to read point\(s\) '<OBJ.VAR.IDX – OBJ.VAR.IDX>' on device '<device>'. Device does not support requested operation for objects in the request \(IIN2.1\)](#)

[Unable to read point\(s\) '<OBJ.VAR.IDX – OBJ.VAR.IDX>' on device '<device>'. Device does not support the](#)

function code (IIN2.0)

[Unable to read point\(s\) '<OBJ.VAR.IDX – OBJ.VAR.IDX>' on device '<device>'. Device reports that some output points are in local mode \(IIN1.5\)](#)

[Unable to read point\(s\) '<OBJ.VAR.IDX – OBJ.VAR.IDX>' on device '<device>'. Device reports that the operation is already executing \(IIN2.4\)](#)

[Unable to read point\(s\) '<OBJ.VAR.IDX – OBJ.VAR.IDX>' on device '<device>'. Response missing data](#)

[Unable to read point\(s\) '<OBJ.VAR.IDX – OBJ.VAR.IDX>' on device '<device>'. Session shutting down or duplicate request](#)

[Unable to read point\(s\) '<OBJ.VAR.IDX – OBJ.VAR.IDX>' on device '<device>'. Unrecognized Object returned in Response](#)

Unable to read point(s) '<OBJ.VAR.IDX>' on device '<device>'. An abnormal condition exists in the device (IIN1.6)

Error Type:

Warning

Possible Cause:

An abnormal condition has occurred that is specific to the device.

Solution:

Resolve any hardware issues found in the slave.

Unable to read point(s) '<OBJ.VAR.IDX>' on device '<device>'. Device detected corrupt configuration (IIN2.5)

Error Type:

Warning

Possible Cause:

The device has detected that its configuration is corrupt.

Solution:

Reconfigure the slave.

Unable to read point(s) '<OBJ.VAR.IDX>' on device '<device>'. Device does not support a point in the range or other parameter error (IIN2.2)

Error Type:

Warning

Possible Cause:

1. The device does not support a point in the specified range.
2. The device does not understand the parameters sent in the request.

Solution:

Change the point(s) to one supported by the slave.

Unable to read point(s) '<OBJ.VAR.IDX>' on device '<device>'. Device does not support requested operation for objects in the request (IIN2.1)

Error Type:

Warning

Possible Cause:

The device does not support the requested operation for the objects in the request.

Solution:

Verify that the slave supports the requested operation.

Unable to read point(s) '<OBJ.VAR.IDX>' on device '<device>'. Device does not support the function code (IIN2.0)

Error Type:

Warning

Possible Cause:

The device does not support the function code.

Solution:

None.

Note:

For more information, refer to the device's documentation.

Unable to read point(s) '<OBJ.VAR.IDX>' on device '<device>'. Device reports that some output points are in local mode (IIN1.5)

Error Type:

Warning

Possible Cause:

Some output points are in local mode.

Solution:

Correct the mode in the slave's configuration.

Note:

For more information, refer to the device's documentation.

Unable to read point(s) '<OBJ.VAR.IDX>' on device '<device>'. Device reports that the operation is already executing (IIN2.4)

Error Type:

Warning

Possible Cause:

The specified point is being acted upon by another client.

Solution:

1. Stop the other client from acting upon the points.
2. Delay the operation of the points.

Unable to read point(s) '<OBJ.VAR.IDX>' on device '<device>'. Response missing data

Error Type:

Warning

Possible Cause:

Although the response from the slave indicated success, data for one or more points in the requested range was not included in the response.

Solution:

Confirm that the points are enabled in the slave.

Unable to read point(s) '<OBJ.VAR.IDX>' on device '<device>'. Session shutting down or duplicate request

Error Type:

Warning

Possible Cause:

The client disconnected while a transaction was in progress.

Solution:

Confirm that the connection between the master and the slave is okay.

Unable to read point(s) '<OBJ.VAR.IDX>' on device '<device>'. Unrecognized Object returned in Response

Error Type:

Warning

Possible Cause:

The slave does not support the Read request.

Solution:

Change the request to one supported by the slave.

Unable to read point(s) '<OBJ.VAR.IDX – OBJ.VAR.IDX>' on device '<device>'. An abnormal condition exists in the device (IIN1.6)

Error Type:

Warning

Possible Cause:

An abnormal condition has occurred that is specific to the device.

Solution:

Resolve any hardware issues found in the slave.

Unable to read point(s) '<OBJ.VAR.IDX – OBJ.VAR.IDX>' on device '<device>'. Device detected corrupt configuration (IIN2.5)

Error Type:

Warning

Possible Cause:

The device has detected that its configuration is corrupt.

Solution:

Reconfigure the slave.

Unable to read point(s) '<OBJ.VAR.IDX – OBJ.VAR.IDX>' on device '<device>'. Device does not support a point in the range or other parameter error (IIN2.2)

Error Type:

Warning

Possible Cause:

1. The device does not support a point in the specified range.
2. The device does not understand the parameters sent in the request.

Solution:

Change the points to ones supported by the slave.

Unable to read point(s) '<OBJ.VAR.IDX – OBJ.VAR.IDX>' on device '<device>'. Device does not support requested operation for objects in the request (IIN2.1)**Error Type:**

Warning

Possible Cause:

The device does not support the requested operation for the objects in the request.

Solution:

Verify that the slave supports the requested operation.

Unable to read point(s) '<OBJ.VAR.IDX – OBJ.VAR.IDX>' on device '<device>'. Device does not support the function code (IIN2.0)**Error Type:**

Warning

Possible Cause:

The device does not support the function code.

Solution:

None.

Note:

For more information, refer to the device's documentation.

Unable to read point(s) '<OBJ.VAR.IDX – OBJ.VAR.IDX>' on device '<device>'. Device reports that some output points are in local mode (IIN1.5)**Error Type:**

Warning

Possible Cause:

Some output points are in local mode.

Solution:

Correct the mode in the slave's configuration.

Note:

For more information, refer to the device's documentation.

Unable to read point(s) '<OBJ.VAR.IDX – OBJ.VAR.IDX>' on device '<device>'. Device reports that the operation is already executing (IIN2.4)**Error Type:**

Warning

Possible Cause:

The specified points are being acted upon by another client.

Solution:

1. Stop the other client from acting upon the points.
2. Delay the operation of the points.

**Unable to read point(s) '<OBJ.VAR.IDX – OBJ.VAR.IDX>' on device '<device>'.
Response missing data**

Error Type:

Warning

Possible Cause:

Although the response from the slave indicated success, data for one or more points in the requested range was not included in the response.

Solution:

Confirm that the points are enabled in the slave.

**Unable to read point(s) '<OBJ.VAR.IDX – OBJ.VAR.IDX>' on device '<device>'. Session
shutting down or duplicate request**

Error Type:

Warning

Possible Cause:

The client disconnected while a transaction was in progress.

Solution:

Confirm that the connection between the master and the slave is okay.

**Unable to read point(s) '<OBJ.VAR.IDX – OBJ.VAR.IDX>' on device '<device>'.
Unrecognized Object returned in Response**

Error Type:

Warning

Possible Cause:

The slave does not support the Read request.

Solution:

Change the request to one supported by the slave.

Write Errors

The following error/warning messages may be generated. Click on the link for a description of the message.

Write Errors

[Unable to write to '<address>' on device '<device>'. An abnormal condition exists in the device \(IIN1.6\)](#)

[Unable to write to '<address>' on device '<device>'. Control-Related Status Code '<status code>'](#)

[Unable to write to '<address>' on device '<device>'. Device detected corrupt configuration \(IIN2.5\)](#)

[Unable to write to '<address>' on device '<device>'. Device does not support a point in the range or other parameter error \(IIN2.2\)](#)

[Unable to write to '<address>' on device '<device>'. Device does not support requested operation for objects in the request \(IIN2.1\)](#)

[Unable to write to '<address>' on device '<device>'. Device does not support the function code \(IIN2.0\)](#)

[Unable to write to '<address>' on device '<device>'. Device reports that some output points are in local mode \(IIN1.5\)](#)

[Unable to write to '<address>' on device '<device>'. Device reports that the operation is already executing](#)

(IIN2.4)

[Unable to write to '<address>' on device '<device>'. Select Operate response invalid](#)

[Unable to write to '<address>' on device '<device>'. Session shutting down or duplicate request](#)

[Unable to write to '<address>' on device '<device>'. Unrecognized Object returned in Response](#)

[Unable to write to '<address>' on device '<device>'. Unsupported Operation Type](#)

[Unable to write to '<address>' on device '<device>'. Unsupported Trip-Close Code](#)

[Unable to write to '<address>' on device '<device>'. Write value specified is invalid](#)

[Unable to write to address '<master address>' on device '<device>'. Master Address must be between '<min master address>' and '<max master address>'](#)

[Unable to write to address '<slave address>' on device '<device>'. Slave Address must be between '<min slave address>' and '<max slave address>'](#)

Unable to write to '<address>' on device '<device>'. An abnormal condition exists in the device (IIN1.6)

Error Type:

Warning

Possible Cause:

An abnormal condition has occurred that is specific to the device.

Solution:

Resolve any hardware issues found in the slave.

Unable to write to '<address>' on device '<device>'. Control-Related Status Code '<status code>'

Error Type:

Warning

Possible Cause:

The value written to the .Operate sub-type was not understood by the DNP slave.

Solution:

For information on a specific code number, refer to the table below.

Code Number	Identifier Name	Description
0	SUCCESS	Request accepted, initiated, or queued.
1	TIMEOUT	Request not accepted because the operate message was received after the arm timer timed out. The arm timer was started when the select operation for the same point was received.
2	NO_SELECT	Request not accepted because no previous matching select request exists. An operate message was sent to activate an output that was not previously armed with a matching select message.
3	FORMAT_ERROR	Request not accepted because there were formatting errors in the control request (either select, operate, or direct operate).
4	NOT_SUPPORTED	Request not accepted because a control operation is not supported for this point.
5	ALREADY_ACTIVE	Request not accepted because the control queue is full (or the point is already active).
6	HARDWARE_ERROR	Request not accepted because of control hardware problems.
7	LOCAL	Request not accepted because the Local/Remote switch is in the Local position.
8	TOO_MANY_OBJS	Request not accepted because too many objects appeared in the same request.
9	NOT_AUTHORIZED	Request not accepted because of insufficient authorization.

10	AUTOMATION_INHIBIT	Request not accepted because it was prevented or inhibited by a local automation process.
11	PROCESSING_LIMITED	Request not accepted because the device cannot process any more activities than are presently in progress.
12	OUT_OF_RANGE	Request not accepted because the value is outside the acceptable range permitted for this point.
13 to 125	RESERVED	Reserved for future use.
126	NON_PARTICIPATING	Sent in request messages indicating that the outstation will neither issue nor perform the control operation.
127	UNDEFINED	Request not accepted due to an undefined reason.

Unable to write to '<address>' on device '<device>'. Device detected corrupt configuration (IIN2.5)

Error Type:

Warning

Possible Cause:

The device has detected that its configuration is corrupt.

Solution:

Reconfigure the slave.

Unable to write to '<address>' on device '<device>'. Device does not support a point in the range or other parameter error (IIN2.2)

Error Type:

Warning

Possible Cause:

1. The device does not support a point in the specified range.
2. The device does not understand the parameters sent in the request.

Solution:

Change the tag address to one supported by the slave.

Unable to write to '<address>' on device '<device>'. Device does not support requested operation for objects in the request (IIN2.1)

Error Type:

Warning

Possible Cause:

The device does not support the requested operation for the objects in the request.

Solution:

Verify that the slave supports the requested operation.

Unable to write to '<address>' on device '<device>'. Device does not support the function code (IIN2.0)

Error Type:

Warning

Possible Cause:

The device does not support the function code.

Solution:

None.

Note:

For more information, refer to the device's documentation.

Unable to write to '<address>' on device '<device>'. Device reports that some output points are in local mode (IIN1.5)

Error Type:

Warning

Possible Cause:

Some output points are in local mode.

Solution:

Correct the mode in the slave's configuration.

Note:

For more information, refer to the device's documentation.

Unable to write to '<address>' on device '<device>'. Device reports that the operation is already executing (IIN2.4)

Error Type:

Warning

Possible Cause:

The specified address is being acted upon by another client.

Solution:

1. Stop the other client from acting upon the address.
2. Delay the operation of the address.

Unable to write to '<address>' on device '<device>'. Select Operate response invalid

Error Type:

Warning

Possible Cause:

The device did not return an acceptable response to a Select then Operate request.

Solution:

Verify that the slave is configured to operate on the point.

Unable to write to '<address>' on device '<device>'. Session shutting down or duplicate request

Error Type:

Warning

Possible Cause:

The client disconnected while a transaction was in progress.

Solution:

Confirm that the connection between the master and the slave is okay.

Unable to write to '<address>' on device '<device>'. Unrecognized Object returned in Response

Error Type:

Warning

Possible Cause:

The slave does not support the value being written to the object group.

Solution:

Change the value to one supported by the slave.

Unable to write to '<address>' on device '<device>'. Unsupported Operation Type

Error Type:

Fatal

Possible Cause:

An invalid DNP operation code was specified when writing to the .Operate.OpType tag.

Solution:

Correct the .Operate.OpType tag's value.

Unable to write to '<address>' on device '<device>'. Unsupported Trip-Close Code

Error Type:

Fatal

Possible Cause:

An invalid DNP Trip-Close code was specified when writing to the .Operate.TripCloseCode tag.

Solution:

Correct the .Operate.TripCloseCode tag's value.

Unable to write to '<address>' on device '<device>'. Write value specified is invalid

Error Type:

Warning

Possible Cause:

An invalid value was written to Operate.Set, Operate, object group 60, Warmrestart, or Coldrestart tag.

Solution:

Correct the value written to the Operate.Set, Operate, object group 60, Warmrestart, or Coldrestart tag.

Unable to write to address '<master address>' on device '<device>'. Master Address must be between '<min master address>' and '<max master address>'

Error Type:

Warning

Possible Cause:

The value written is out of range.

Solution:

The Master Address ranges between a minimum value of 0 and a maximum value of 65519. Specify a write value within

this range.

Unable to write to address '<slave address>' on device '<device>'. Slave Address must be between '<min slave address>' and '<max slave address>'

Error Type:

Warning

Possible Cause:

The value written is out of range.

Solution:

The Slave Address ranges between a minimum value of 0 and a maximum value of 65519. Specify a write value within this range.

Device Profile

For more information on a specific section of the Device Profile, select a link from the list below.

[Device Identification](#)

[Link Layer](#)

[Application Layer](#)

[Masters Only](#)

Note: For a Device Profile template, refer to DNP.org.

Device Identification

Component	Description	Current Value	Methods
Device Function	Masters send DNP requests.	Master	
Device Name	This is the model and name of the device, which should distinguish it from any other device from the same organization.	DNP Master Serial	
Hardware Version		- Windows 7 - Windows Server 2008 - Windows Vista Business/ Ultimate - Windows Server 2003 SP2 - Windows XP SP2 - Windows 2000 SP4	
Software Version		v.5	
Device Profile Document Version	The version of the Device Profile Document is indicated by a whole number incremented with each new release.	1	
DNP Levels Supported for Requests	The DNP3 level to which the device conforms fully. Requests can be indicated independently.	2	
DNP Levels Supported for Responses	The DNP3 level to which the device conforms fully. Responses can be indicated independently.	2	
Supported Function Blocks			
Notable Additions	This brief description intends to identify the most obvious	- Enabling and disabling unsolicited responses on	For more information, refer to Address

	features that the device supports, in addition to the highest supported level of DNP. The complete list of features is described in the Implementation Table.	an individual class basis. - Double-bit Input Objects. - Variations with time for Frozen Counters, Frozen Counter Events, and Analog Input Events. - Floating point variations for both Analog Inputs and Analog Outputs. - Analog Input Reporting Deadband. - Event Objects for Binary and Analog Outputs.	Descriptions.
Methods to Set Configurable Parameters			Methods include .opf and .xml project files.*

*In addition to custom Channel Properties and Device Properties dialogs.

Serial Connections

Component	Description	Current Value	Methods
Serial Port Name	This is the name used to reference the communication port defined in this section.	COM1	The property located on Channel Communications Property page. Ranges from COM1 to COM255.
Serial Connection Parameters		Data Bits - 8. Stop Bits - 1. Parity - None.	Properties located on Channel Communications Property page. Supported parameters are as follows: Data Bits: 5, 6, 7, or 8. Stop Bits: 1 or 2. Parity: None, Even, Odd.
Serial Baud Rate		9600	Property located on Channel Communications Property page.*
Serial Hardware Flow Control	This parameter describes the interface's hardware signaling requirements. If a transmitter or receiver is inhibited until a given control signal is asserted, it is considered to require that signal prior to sending or receiving characters. If a signal is asserted prior to transmitting, that signal will be maintained actively until after the end of transmission. If a signal is asserted to enable reception, any data sent to the device when the signal is not active could be discarded.	None.	Property located on Channel Communications Property page. Supported flow controls are as follows: - DTR - RTS - RTS-DTR - RTS Always

*Supported baud rates are as follows: 300, 600, 1200, 2400, 9600, 19200, 28800, 38400, 56000, 57600, 115200, 128000, and 256000.

**If no asynchronous serial interface is fitted, this parameter is not applicable. Furthermore, none of the options will be selected.

Application Layer

Component	Description	Current Value	Methods
Maximum Number of Octets Transmitted in an Application Layer Fragment other than File Transfer	This size does not include any transport or frame octets. Masters must provide a setting less than or equal to 249.	249	
Maximum Number of Octets Transmitted in an Application Layer Fragment Containing File Transfer			
Maximum Number of Octets that can be Received in an Application Layer Fragment	This size does not include any transport or frame octets. Masters must provide a setting greater than or equal to 2048.	2048	
Timeout waiting for Complete Application Layer Fragment	Timeout if all frames of a message fragment are not received in the specified time. It is measured from the time that the first frame of a fragment is received until the last frame is received.		
Maximum Number of Objects Allowed in a Single Control Request for CROB (g12)			
Maximum Number of Objects Allowed in a Single Control Request for Analog Outputs (g41)			
Maximum Number of Objects Allowed in a Single Control Request for Data Sets (g85, 86, 87)			
Supports Mixing Object Groups* in the Same Control Request			

*AOBs, cROBs, and Data Sets.

Link Layer

Component	Description	Current Value	Methods
Data Link Address	This indicates if the link address is configurable over the entire valid range of 0 to 65519.	Ranges from 0 to 65519.	Slave Address property located on Device Communications Property page.

Sends Confirmed User Data Frames	This is a list of conditions under which the device transmits the following confirmed link layer services: TEST_LINK_STATES RESET_LINK_STATES CONFIRMED_USER_DATA	Never.	
Data Link Layer Confirmation Timeout	This timeout applies to any secondary data link message that requires a confirmation or response (such as link reset, link status, user data, and so forth).	2 seconds.	
Maximum Data Link Retries	This is the number of times that the device will retransmit a frame that requests Link Layer confirmation.	3 retries.	
Maximum Number of Octets Transmitted in a Data Link Frame	This number includes the checksum. With a length field of 255, the maximum size would be 292.	292	
Maximum Number of Octets that can be Received in a Data Link Frame	This number includes the checksum. With a length field of 255, the maximum size would be 292. The device must be able to receive 292 octets to be compliant.	292	

*Data link addresses 0xFFFF0 through 0xFFFF are reserved for broadcast or other special purposes.

Masters Only

Component	Description	Current Value	Methods
Timeout Waiting for Complete Application Layer Response	Timeout on Master if all fragments of a response message are not received in the specified time.	10000 ms.	Property located on the Channel Communications Property page. Supported response timeouts are 100 to 3600000.
Maximum Application Layer Retries for Request Messages	This is the number of times a Master will retransmit an application layer request message if a response is not received. This parameter must never cause a Master to retransmit control or time sync messages.	None.	
Incremental Timeout Waiting for First or Next Fragment of an Application Layer Response		None.	

Index

- A -

Address '<address>' is not valid on device '<channel>' '<device>' 24
 Address '<address>' is out of range for the specified device or register 25
 Address Descriptions 13
 Address Validation 24
 Advanced 10
 Application Layer 41

- C -

Channel Setup 4
 Communications 6

- D -

Data type '<type>' is not valid for device address '<address>' 25
 Data Types Description 12
 Device '<device name>' is not responding 26
 Device '<device>' does not support the LAN Time Sync Style Record Current Time Function Code 24 26
 Device '<device>' indicated an event buffer overflow (IIN 2.3) 26
 Device '<device>' Restarting 26
 Device address '<address>' contains a syntax error 25
 Device address '<address>' is Read Only 25
 Device Identification 39
 Device Profile 39
 Device Setup 5
 Device Status Messages 25
 DNP Addressing 16
 DNP Advanced Operations 22
 DNP Specific Error Messages 29
 DWord 12

- E -

Error Descriptions 23
 Event Playback 9

- H -

Help Contents 4

- L -

Link Layer 41

- M -

Masters Only 42
 Modem Setup 12

- O -

Object Definitions 20
 Overview 4

- P -

Polling 7

- R -

Reached Max Events Per Point for Object Group '<object group>' Point '<data index>' on Device '<device>' 27
 Read Errors 29

- T -

Timing and Other Considerations 11

- U -

Unable to read point(s) '<OBJ.VAR.IDX – OBJ.VAR.IDX>' on device '<device>'. An abnormal condition exists in the device (IIN1.6) 32
 Unable to read point(s) '<OBJ.VAR.IDX – OBJ.VAR.IDX>' on device '<device>'. Device detected corrupt configuration (IIN2.5) 32
 Unable to read point(s) '<OBJ.VAR.IDX – OBJ.VAR.IDX>' on device '<device>'. Device does not support a point in the range or other parameter error (IIN2.2) 32

- Unable to read point(s) '<OBJ.VAR.IDX – OBJ.VAR.IDX>' on device '<device>'. Device does not support requested operation for objects in the request (IIN2.1) 33
- Unable to read point(s) '<OBJ.VAR.IDX – OBJ.VAR.IDX>' on device '<device>'. Device does not support the function code (IIN2.0) 33
- Unable to read point(s) '<OBJ.VAR.IDX – OBJ.VAR.IDX>' on device '<device>'. Device reports that some output points are in local mode (IIN1.5) 33
- Unable to read point(s) '<OBJ.VAR.IDX – OBJ.VAR.IDX>' on device '<device>'. Device reports that the operation is already executing (IIN2.4) 33
- Unable to read point(s) '<OBJ.VAR.IDX – OBJ.VAR.IDX>' on device '<device>'. Failed to initialize communication stack 28
- Unable to read point(s) '<OBJ.VAR.IDX – OBJ.VAR.IDX>' on device '<device>'. Internal Error occurred 28
- Unable to read point(s) '<OBJ.VAR.IDX – OBJ.VAR.IDX>' on device '<device>'. Response missing data 34
- Unable to read point(s) '<OBJ.VAR.IDX – OBJ.VAR.IDX>' on device '<device>'. Session shutting down or duplicate request 34
- Unable to read point(s) '<OBJ.VAR.IDX – OBJ.VAR.IDX>' on device '<device>'. Unrecognized Object returned in Response 34
- Unable to read point(s) '<OBJ.VAR.IDX>' on device '<device>'. An abnormal condition exists in the device (IIN1.6) 30
- Unable to read point(s) '<OBJ.VAR.IDX>' on device '<device>'. Device detected corrupt configuration (IIN2.5) 30
- Unable to read point(s) '<OBJ.VAR.IDX>' on device '<device>'. Device does not support a point in the range or other parameter error (IIN2.2) 30
- Unable to read point(s) '<OBJ.VAR.IDX>' on device '<device>'. Device does not support requested operation for objects in the request (IIN2.1) 30
- Unable to read point(s) '<OBJ.VAR.IDX>' on device '<device>'. Device does not support the function code (IIN2.0) 31
- Unable to read point(s) '<OBJ.VAR.IDX>' on device '<device>'. Device reports that some output points are in local mode (IIN1.5) 31
- Unable to read point(s) '<OBJ.VAR.IDX>' on device '<device>'. Device reports that the operation is already executing (IIN2.4) 31
- Unable to read point(s) '<OBJ.VAR.IDX>' on device '<device>'. Failed to initialize communication stack 27
- Unable to read point(s) '<OBJ.VAR.IDX>' on device '<device>'. Internal Error occurred 27
- Unable to read point(s) '<OBJ.VAR.IDX>' on device '<device>'. Response missing data 31
- Unable to read point(s) '<OBJ.VAR.IDX>' on device '<device>'. Session shutting down or duplicate request 32
- Unable to read point(s) '<OBJ.VAR.IDX>' on device '<device>'. Unrecognized Object returned in Response 32
- Unable to receive entire poll response from device '<device>' within Response Timeout. Increase Response Timeout to resolve 28
- Unable to write to '<address>' on device '<device>'. Internal Error occurred 29
- Unable to write to '<address>' on device '<device>'. Unrecognized Object returned in Response 38
- Unable to write to '<address>' on device '<device>'. Write value specified is invalid 38
- Unable to write to '<address>' on device '<device>'. An abnormal condition exists in the device (IIN1.6) 35
- Unable to write to '<address>' on device '<device>'. Control-Related Status Code '<status code>' 35
- Unable to write to '<address>' on device '<device>'. Device detected corrupt configuration (IIN2.5) 36
- Unable to write to '<address>' on device '<device>'. Device does not support a point in the range or other parameter error (IIN2.2) 36
- Unable to write to '<address>' on device '<device>'. Device does not support requested operation for objects in the request (IIN2.1) 36
- Unable to write to '<address>' on device '<device>'. Device does not support the function code (IIN2.0) 36
- Unable to write to '<address>' on device '<device>'. Device reports that some output points are in local mode (IIN1.5) 37
- Unable to write to '<address>' on device '<device>'. Device reports that the operation is already executing (IIN2.4) 37
- Unable to write to '<address>' on device '<device>'. Failed to initialize communication stack 28
- Unable to write to '<address>' on device '<device>'. Select Operate response invalid 37
- Unable to write to '<address>' on device '<device>'. Session shutting down or duplicate request 37
- Unable to write to '<address>' on device '<device>'. Unsupported Operation Type 38
- Unable to write to '<address>' on device '<device>'. Unsupported Trip-Close Code 38

Unable to write to address '<master address>' on device '<device>'. Master Address must be between '<min master address>' and '<max master address>' 38

Unable to write to address '<slave address>' on device '<device>'. Slave Address must be between '<min slave address>' and '<max slave address>' 39

Unsolicited Messaging 9

- W -

Write Errors 34